



Golden opportunity to own DDA Flat at Discounted Price

DDA SPECIAL HOUSING SCHEME 2021

From
23.12.2021 to
07.02.2022



Flats at Discounted Rates
PMAY scheme benefits
as per
Credit Linked Subsidy Scheme

Approx.
18000
Flats



The scheme has the following main features:-

- i) The flats are being offered at the discounted cost. The cost of the flats is likely to increase w.e.f 1st April, 2022.
- ii) 40% concession in construction cost for EWS flats at Pkt.1A, 1B & 1C Sector A1-A4 Narela
- iii) 10% concession in construction cost for EWS flat at Pkt. V Sector G7/G8 Narela
- iv) The flats at Narela sub-city are being offered after taking several remedial measures in terms of improvement of infrastructure, security and connectivity on the basis of suggestions/feedback of the earlier allottees/ residents of the area.
- v) The allottees will be eligible for subsidy under PMAY scheme of the central govt. if they avail home loan from the Bank/Financial Institution.
- vi) The entire process from application to allotment and possession is being done through online mode. The allottee need to visit DDA office only for execution of CD.
- vii) Estimate Approval Committee (EAC) of DDA, under Chairmanship of Vice-Chairman, DDA on 28.10.2021 approved schemes at sector G2 & G6, Narela for

construction of 20 m wide road of about 10 km, water supply lines, storm water drains, sewage treatment, boundary wall construction, augmenting electric supply by establishing Electric Grid Sub-station and street light maintenance.

- viii) Allocation were made in DDA's Annual Budget 2021-22 for transport infrastructure projects such as grant to DMRC towards construction of phase IV Metro line for Rithala-Bawana-Narela corridor and construction of UER-II stretch in Delhi through NHAI.
- ix) Flyover cum ROB is recently inaugurated in Narela.



**DELHI DEVELOPMENT AUTHORITY
LIBRARY
PRESS CLIPPING SERVICE**

NAME OF NEWSPAPERS: _____ DATE: _____

Two New Sectors In Narela To Give A Feel Of Dwarka

DDA Committee Nod To ₹825cr Plan For Sub-City In N Delhi

Three New Sectors

ROAD TO DEVELOPMENT

New sectors will be developed in Narela. DDA committee has approved the plan for two new sectors in Narela. The plan is worth ₹825 crore. The plan includes the construction of 10,000 flats. The plan also includes the construction of a 20m wide road. The plan also includes the construction of water supply lines, storm water drains, sewage treatment, boundary wall construction, augmenting electric supply by establishing Electric Grid Sub-station and street light maintenance.

FEATURES

- 10,000 flats
- 20m wide road
- Water supply lines
- Storm water drains
- Sewage treatment
- Boundary wall construction
- Augmenting electric supply
- Establishing Electric Grid Sub-station
- Street light maintenance



HOUSING SCHEME AT SECTOR A-1 TO A-4 OF NARELA DELHI

SALIENT FEATURES

1. Location :-

- i) Well connected with Major Roads, Railway Station, proposed Metro Line.
- ii) Delhi Karnal National Highway is only 2km away,
- iii) Eight lane Master Plan Road connects the Housing Sector to National Highway, Rohini and West Delhi
- iv) Narela Railway Station is only 2km away.
- v) Proposed Metro Line in close proximity.

2. Hospital Facilities :-

Prominent hospital within a radius of 2km namely

- i) Sataywadi Raja Harish Chander Hospital (Govt. Hospital)
- ii) Febris Hospital

3. Educational Facilities:-

- One High school already running & some more private schools are coming up.
- Land has already been earmarked for the Central Schools besides the primary & Secondary School, within the pocket.
- NIT Delhi is only 2km away.

4. Market Facilities:-

- Built in shops/commercial area exists within complex to cater for the day-to-day requirements
- Car & Scooter parking

5. Parks / Green area:-

- Well maintained parks are already existing for children /toddler playground.

6. Community Hall:-

- Facility of community hall available inside the housing pockets.

7. DDA Sport complex Narela: In close proximity

8. DDA Smriti Van Narela: In close proximity

9. Integrated Freight Complex, Chemical Traders Market, only 2 to 3 km away from the Sector A-1 TO A-4, Narela

ACTUAL PHOTOGRAPH





HOUSING POCKETS IV & V AT SECTOR G7/G8, NARELA

SALIENT FEATURES

1. Well connected by Road, train and proposed metro

- With National Highway and Rohini through UER-I and UER-II (NOW National Highway)
- Narela Railway Station: In close proximity
- Proposed metro line in close proximity

2. Education:-

- Provision for Senior Secondary School
- NIT Delhi already functional

3. Market:-

- Both housing pockets have 8 nos of shops within pockets for daily need

- Provision for Convenient Shopping Complex (CSC), Local Shopping Complex (LSC) and Police Post.
- Integrated freight complex

4. Health :-

- Satyawadi Raja Harish Chand Hospital at Sector A7, Narela at 5.30 km
- Provision of Hospital in Sector G7/G8 Narela within a radius of 650m.



ACTUAL PHOTOGRAPH



SPECIAL HOUSING SCHEME 2021

1. SCHEME:-

- 1.1. The Scheme is titled as “**Special Housing Scheme 2021**” of the Delhi Development Authority for disposal of flats.

2. ELIGIBILITY:

- 2.1. The applicant must be a citizen of India.
- 2.2. He/ She should have attained the age of majority i.e. an applicant should have completed 18 years of age as on the last date of submission of the application.
- 2.3. A dwelling unit or flat in the Housing Estates of the Authority shall be allotted only to such person who or his wife or her husband or any of his/her dependent relations including unmarried children does not own in full or in part on free hold or lease hold basis a residential plot having area exceeding 67 sqm or flat/built up house having carpet area

exceeding 67 sqm in the urban area of Delhi, New Delhi and Delhi Cantonment.

- 2.4. Both husband and wife can apply for flats separately subject to fulfilment of eligibility conditions with the stipulation that if both are declared successful, only one shall be allotted a flat and the amount of ‘Application Money’ of the other spouse will be refunded.
- 2.5. **One person can submit only one application either in his/her own name or as a joint/co-applicant.***
- 2.6. **The individual income of applicant as well as of joint/co-applicant applying for EWS flats should not exceed Rs.3 lakhs per annum and Household income should not exceed Rs. 10 Lakh per annum.** There is no income criterion for other categories except EWS. The applicant can apply according to his/her requirement and affordability.

Household Income for this clause is defined as follows:

In case:	Following will be included in the Household income
a. The applicant is more than 25 years of age	Income will comprise of that of applicant, spouse, unmarried son/s and unmarried/ widowed/ divorcee daughter/s, if they are dependent on the applicant
b. The applicant is less than 25 years of age, Age group of 18-25 Years (If married)	Income of applicant & spouse, Income of children and parents will also be included if they are dependent on the applicant.
c. The applicant is less than 25 years of age, Age group of 18-25 Years (If unmarried)	Income of applicant along with that of parents if they are dependent on the applicant or vice versa.

- 2.7. The applicant should give particulars of his savings account in any Bank in the ‘Application Form’.
- 2.8. Applicant must have Permanent Account Number (PAN) allotted under the provisions of the Income Tax Act and the same must be quoted in the Application Form.
- 2.9. In case of joint application under SC/ST Reserved Category, the joint applicant/co-applicant should be from within the Family, as defined in sub-clause (2.11) below.
- 2.10. In case of joint application under war widows, Persons with Disabilities (Divyangjan), ex-servicemen and other reserved categories, the applicant himself/herself should fall within the

respective reserved category and the joint applicant/co-applicant should be from within the Family as defined in sub-clause (2.11) below.

- 2.11. Family for clause (2.9) and (2.10) above means a person or his/her parents or his/her blood relatives or his/her spouse or any of his/her dependent relative/s including unmarried children.

3. HOW TO APPLY: -

- 3.1. The applications under this scheme shall be accepted through online mode only. For applying online, the applicant is required to visit DDA's website i.e., www.dda.gov.in/www.dda.org.in.
- 3.2. The registration amount/application money for applying for flats under this Scheme shall be as under:-

Sl. no.	Flat Category	Registration Money	Application Processing Fee (Non refundable)*	Total
i.	EWS/JANTA*	Rs. 25,000/-	Rs. 2,000/-*	Rs. 27,000/-*
ii.	LIG	Rs. 1,00,000/-	Rs. 2,000/-	Rs. 1,02,000/-
iii.	MIG	Rs. 2,00,000/-	Rs. 2,000/-	Rs. 2,02,000/-
iv.	HIG	Rs. 2,00,000/-	Rs. 2,000/-	Rs. 2,02,000/-

* In case the applicant belongs to **Reserve Categories as mentioned in para 5 and EWS Category** Application Processing Fee will be **Rs. 1,000/-** only (non-refundable).



- 3.3. In case, if an applicant wish to apply in more than one category, he/she would require to deposit registration amount/ application processing fee payable in respect of higher or the highest category, as the case may be.
- 3.4. Application once submitted cannot be withdrawn.
- 3.5. The process of Application, Issuance of Demand Letter, Possession letter, Conveyance Deed etc. and uploading of documents will be through On-Line Mode only. Applicants are advised to keep their login credentials safe with them and not to share the same with anyone. DDA will not be responsible for any unauthorized use of login credentials. It will be sole responsibility of the applicant to regularly check the portal for any updates.
- 3.6. The applicant may give one or more preferences of his/her choice, subject to a maximum of 7 by filling the locality codes, given in Annexure 'A'. It is mandatory to fill at least one preference for locality. **It is presumed that applicant has seen/visited the**

locality/flat/pocket before giving preferences. No preference for Sector/Pocket can be exercised by the applicant. No request for change of locality, sector, pocket shall be entertained by the DDA.

- 3.7. **Since the application will be accepted through online mode only, conditional application will not be accepted.**
- 3.8. The applicant doesn't need to submit any document at the time of submission of application. Only the successful applicants will be required to submit the prescribed supporting documents.

4. REFUND OF REGISTRATION MONEY TO APPLICANTS:

4.1. Successful Applicants

- 4.1.1. The applicants are advised to satisfy themselves with regard to location, cost, existing facilities in the surrounding area and other related issues before applying for allotment of a flat under this scheme. The surrender/cancellation charges, as prescribed below, shall be recovered:-

S.No	Period	Surrender/ Cancellation charges
(a)	From the date of draw and upto 15th day from the date of issue of demand cum allotment letter block start date.	10% of the Registration Money subject to a maximum of Rs 10,000/-.
(b)	From the 16th day till 30th day from the date of issue of demand cum allotment letter block start date.	20% of the Registration Money applicable to the Allotted Category
(c)	From 31st day till 90th day from the date of issue of demand cum allotment letter block start date.	50% of the Registration/Application Money applicable to the Allotted Category
(d)	After 90 days from the date of issue of demand cum allotment letter.	Full Application Money applicable to the Allotted Category

- 4.1.2. DDA will not be responsible for any delay in refund of application money due to wrong/mismatch in bank details provided by the applicant. Surrender/Cancellation request will be accepted through Online Mode Only.

4.2. Unsuccessful Applicants

- 4.2.1. For getting the admissible refund of registration money, the Applicant has to clearly mention his/her Saving Bank Account number and the IFSC Code etc. in the Application Form for refund of the application money. In case, the application is in joint name, refund will be made in the name of the first applicant only and therefore, only his/her Bank Account No. should be given in the Application Form. The Bank Account should not be an **NRE/NRO ACCOUNT/CURRENT ACCOUNT.**

- 4.2.2. In case the registration amount/application money has been paid from the Account of the Firm/Company, etc. of the Applicant, still for the purpose of refund, only the applicant's Bank details have to be provided. In case of **mismatch of account number, IFSC Code, payee's name**, the bank would not be in a position to refund the registration money through ONLINE mode. In order to avoid such a situation, the applicant is advised to recheck the bank details before submitting the Application Form. **DDA will not be responsible for any delay of refund in cases of mismatch in the bank account details provided by the applicant.**

Note: The Applicants are requested to ensure that the Bank details provided for the refund should match with the applicant name mentioned in the online application form.

5. RESERVATIONS: -

- 5.1. The details of reservations under this Scheme are as under:-
- 5.1.1. 15% of the flats for applicants belonging to Scheduled Castes(SC); and



- 5.1.2. 7.5% of the flats for applicants belonging to Scheduled Tribes(ST);

Note:

If adequate numbers of applications are not received from applicants belonging to ST Category, remaining flats shall be disposed of in favour of applicants belonging to SC Category and vice-versa.

- 5.1.3. 1% for War Widows and those receiving liberalized pension from Armed/Paramilitary Services (Next of Kin)
- 5.1.4. 5% reservation for Persons with Disability (Divyangjan) as defined in Section-37(a) of the Rights of persons with Disabilities Act, 2016.
- 5.1.5. 1% for Ex-servicemen.
- 5.2. The reservations, as above, are admissible strictly with reference to the number of flats available in a locality.
- 5.3. In case number(s) of flats in respect of reserved category comes to a fraction i.e. less than 0.5 it would be rounded off to zero and if it is 0.5 or more it would be rounded off to one.
- 5.4. If requisite numbers of applications are not received from the above mentioned five categories, all remaining flats shall be offered to persons of unreserved category.

6. DOCUMENTS TO BE SUBMITTED AFTER DRAW OF FLATS & BEFORE POSSESSION OF FLAT:

6.1. For all categories:

- 6.1.1. Self-attested copy of PAN Card (Permanent Account Number) issued/allotted by Income Tax Department.
- 6.1.2. Identity Proof e.g. self-attested copy of passport, government Identity Card, Election ID card, Driving License, Ration Card with Photo (of the person whose photo is affixed) or Aadhaar Card. (Upload any one)
- 6.1.3. Proof of residence e.g. self-attested copy of passport, government Identity Card, Election ID card, Ration card, Driving License, Telephone Bill, Electricity Bill, Water Bill, House Tax Receipt, Bank Pass Book (page carrying name and address of the allottee) or Aadhaar Card.(Upload any one)
- 6.1.4. Proof of Income for EWS Category as issued by the concerned authority.

6.2. For reserved category:

- 6.2.1. In addition to documents mentioned in (6.1) above, successful applicants of the Categories as mentioned above have to submit the followings also:
- 6.2.2. An attested copy of the original caste certificate issued by the District Magistrate/Sub Divisional Magistrate of the area concerned in case the applicant belongs to the SC/ST Category.
- 6.2.3. An attested copy of the original handicapped certificate issued by the Medical Board or a Govt. Hospital in case the applicant is applying under the reserved category of Persons with Disability (Divyangjan). A self-attested copy of guardianship certificate issued by the competent authority, wherever applicable, is also to be attached.
- 6.2.4. An attested copy of Discharge Certificate from the competent authority of Ministry of Defence/Armed Forces in case of ex-Servicemen.
- 6.2.5. An attested copy of "Requisite Certificate" issued by the Ministry of Defence/Armed Forces/Para Military Forces, in case the successful applicant comes under category of War-Widows/Next of Kin which would include those receiving liberalized pension.

6.3. Other Documents:

- 6.3.1. A Self-attested copy of Bank Account Pass Book/Bank Statement from which the cost of the Flat has been deposited along with payment proof.
- 6.3.2. Affidavit as per proforma given in **Annexure-'C' and 'D' of the scheme brochure.**
- 6.3.3. Undertaking as per proforma given in **Annexure-'E' of the scheme brochure.**
- 6.3.4. Photograph and three signatures of self and spouse, (if married), duly attested as per proforma given in **Annexure-'F' of the scheme brochure.**
- 6.3.5. **In addition to above the document mentioned in the Online Portal for Possession needs to be submitted with supporting documents, if any, required.**



7. MODE OF ALLOTMENT:-

- 7.1. All the eligible applicants shall be considered for allotment through a computerized draw based on random number technique. The draw shall be held in the presence of 3 independent Observers. The draw for the Festival Housing Scheme 2021 will be web-streamed to facilitate the applicants to see the proceedings of the draw.

8. RESULT OF ALLOTMENT:-

- 8.1. The results of the draw shall be displayed on DDA's website i.e. www.dda.gov.in/www.dda.org.in.
- 8.2. It shall be the sole responsibility of the applicant to check the result of the draw.
- 8.3. A separate wait list of the applicants equal to 25% of total flats on offer allotted under the draw will also be declared in order of priority. The waiting list will be valid only for 10 months from the date of issue of demand letters to successful applicants. **The application money of wait-listed applicants shall be refunded along with unsuccessful applicants.** However, before going for the draw for allotment of specific flat as per the priority already decided, for allotting the surrendered/cancelled flats, all such eligible wait-listed applicants shall be asked to deposit the application money. **A minimum of 30 days' time shall be given to them to do so and only those names shall be included for the draw, who deposit their Application Money before the prescribed date.**
- 8.4. The demand-cum-allotment letters will be issued through online mode only and it will be the sole responsibility of the applicant to regularly check the online portal for any updates.

9. DISPOSAL COST OF THE FLATS:-

- 9.1. All flats offered under this scheme were put for disposal in earlier schemes like HS-2014, HS 2017, HS 2019 & HS 2021, they are proposed to be disposed off at the cost applicable/ updated for the Financial year 2021-22 except newly constructed flats offered for the 1st time under Housing Scheme 2021, which will be disposed of at the cost of Housing Scheme 2021 without any change.

10. PERIOD OF PAYMENT:-

- 10.1. The cost of the flat is to be deposited within 90 days from the date of issue of Demand-cum-Allotment letter.
- 10.2. Further time of 3 months, over and above (10.1) above, will be available to the allottees subject to

payment of interest at the rate of **10% p.a. (simple interest)**.

- 10.3. The delay in payment of cost beyond 6 months up to further six months may be allowed with the approval of VC, DDA with penal interest @14 % subject to the condition that at least 25% of the cost have been received as per (10.2) above.
- 10.4. If the demanded amount is not paid by the allottee within the time prescribed in Demand-cum allotment letter, the allotment of flat will automatically stand cancelled without any notice and will be made available for allotment to others. In such an event, the entire registration amount/application money will be forfeited.

11. METHOD OF PAYMENT OF DEMANDED AMOUNT:-

- 11.1. The registration amount/application processing fee may be paid from any account. However, demanded amount after issuance of online Demand-cum-Allotment letter should either be deposited from Allottee's own account or from the account of relatives specified hereunder through NEFT/RTGS/ Net Banking. Any charges, of whatever in nature, in this regard shall be borne by the allottee.
- 11.2. The specified relatives mentioned herein above, besides the allottee spouse also include allottee's father, mother, sister, brother, son, daughter, grand-son/ grand-daughter or, wife of the son (daughter-in-law)/ grandson, husband of daughter (son-in-law) or husband of grand-daughter (for the purpose of this definition grand-son/ grand-daughter means a son's or a daughter's child).

12. MODE OF PAYMENT:-

- 12.1. The allotment of flats shall be made on cash down basis only except to the applicants belonging to PwD (Persons with Disability (Divyangjan)) category who will have the option of making payment either on "Cash Down" basis or in Equated Monthly Installments (EMIs) on terms and conditions as applicable in their case.

13. MORTGAGE/AVAILING LOAN:-

- 13.1. The allottee can avail housing loan by mortgaging the flat to following institutions without prior approval of the DDA. However, an intimation regarding institution to which it has been mortgaged must be sent to concerned Dy. Director (Housing), DDA, Vikas Sadan, New Delhi:-
 - 13.1.1. Government of India; State Government; Union Territory Administration;



- 13.1.2. Public Sector Undertakings / Autonomous Bodies;
- 13.1.3. Nationalized Banks;
- 13.1.4. Life Insurance Corporation of India; General Insurance Corporation of India;
- 13.1.5. Housing Development Finance Corporation;
- 13.1.6. Cooperative Banks;
- 13.1.7. MCD; NDMC;
- 13.1.8. All joint sector companies irrespective of the percentage of shareholding;
- 13.1.9. University of Delhi;
- 13.1.10. All organisations, private or public, which receive the approval of Govt. of India, State Govt. for the purpose of general mortgage permission and are recognized by RBI as a Housing Finance Company;
- 13.1.11. All Financial Institutions extending loans to individuals for house building, if they are leading companies with good market standing and repute say with a capital base of Rs.5 Crores or so;
- 13.1.12. All Financial Institutions/Banks which are controlled by RBI or the Govt. of India irrespective of the percentage of Govt. shareholding;
- 13.1.13. All public companies with a capital base of Rs.5 Crores provided they have a Scheme for granting Housing Building Advance/Loan to their employees and the mortgage is required for grant of such advances.

14. MISUSE, ADDITIONS AND ALTERATIONS, ETC.:-

- 14.1. The flat shall be used only for residential purpose and cannot be put to any other use. The allottee shall not be entitled to sub-divide the dwelling unit or amalgamate it with any other dwelling unit or to make any structural additions/alterations.

15. RESPONSIBILITY FOR THE MAINTENANCE OF COMMON PORTIONS AND COMMON SERVICES, ETC.:-

- 15.1. Every successful applicant shall be required to become a member of the Registered Agency/ Association of Apartment Owners to be formed for the purpose of maintenance of common portions and common services for these housing pockets, in accordance with the provision of the law in force for the time being i.e. DDA (Management & Disposal of

Housing Estate) Regulation 1968 in this behalf before the possession of the flat is handed over to him/her. **Only one RWA will be registered for one pocket. All allottees of each pocket shall mandatorily have to become member of the concerned RWA.**

- 15.2. For the purpose of major (capital nature) maintenance, for a period of 10 (ten) years, contribution towards the maintenance fund shall be recovered from the allottees. The Scheme requires that the entire maintenance funds collected would be placed in a corpus as an escrow account and maintenance works (Capital nature) would be undertaken out of the interest earned from the corpus. The fund will be apportioned to the RWAs registered with DDA and will be managed by a Committee in which DDA will be represented by the Executive Engineer of the concerned Zone. The civil and electrical maintenance of all the newly constructed flats will be carried only from the interest arising out of the corpus created for maintenance. In case, there is any shortfall, the concerned RWAs, registered with DDA, will have to bridge the gap through contribution from the allottees and DDA will not contribute any fund towards maintenance. The fund becomes operative from the date the first demand-cum-allotment letter is issued.

15.3. The general principles for maintenance will be as follows:

- 15.3.1. The individual flat owners will be fully responsible for all internal maintenance of their flats after they take over the possession.
- 15.3.2. Major repairs including white-wash of external areas will be carried out on need basis subject to availability of funds. In schemes where maintenance deposit has been taken by DDA, these major repairs will be carried out of the money available from interest as provided in the scheme. The link officer of DDA nominated for the purpose will coordinate with the RWAs to set-up maintenance fund.
- 15.3.3. Day to day maintenance including maintenance of green areas, cleanliness of campus/colony/housing pocket, replacement of light fittings in common areas, maintenance and operation of lifts, payment of electricity bill for common areas etc. will be the responsibility of concerned RWAs



- 15.3.4. For common areas which are common to several housing pockets/ colonies, the responsibility of maintenance will be with urban body, after the area is handed over to the urban body. Till such time that the area is handed over to urban body, maintenance will remain with DDA. While handing over, DDA will clearly mark the area to be maintained by the urban body and area to be maintained by RWAs.
- 15.3.5. Those facilities which are common to more than one RWA like Community Centre, Gyms etc. will be maintained by DDA.
- 15.3.6. RWA will have to maintain a separate fund for day to day maintenance mentioned at (15.3.3) above. Therefore maintenance will be dealt in two separate categories i.e. Major (Capital nature) and day to day maintenance.

16. MIS-REPRESENTATION OR SUPPRESSION OF FACTS:-

- 16.1. If it is established that the applicant has applied although he was not eligible as per conditions laid down in Clause 2 or has falsely claimed the benefit of reservation or has given false affidavit/information including quoting wrong PAN number or suppressed any material fact at any time whatsoever, the application/ allotment will be rejected/cancelled summarily without issuing any show cause notice for the same and the entire amount deposited by the allottee will be forfeited. In case multiple applications are received by any individual, such applications would be marked void before the final draw and registration amount would be refunded. However, if by any chance multiple allotments are made in the draw to a particular individual who has submitted multiple applications in such cases all the allotments to the particular individual would be cancelled and registration money forfeited. This would be without prejudice to DDA's right to take such other action as may be permissible in law, including lodging a police complaint/FIR for misrepresentation to a Govt. Authority.

17. POSSESSION OF FLATS:-

- 17.1. The allottee shall be entitled to take possession only after he/she has paid all the dues and completed all the requisite formalities, and furnished/executed all the required documents mentioned in the scheme brochure /the demand-cum-allotment letter.
- 17.2. **Possession letter will be issued through online mode only, and the allottee has to upload self-attested copies of the requisite documents.**
- 17.3. **After issuance of Possession letter, allottee may**

reserve a date for physical possession through On-Line mode. If the allottee does not take possession of the flat within 3 months from the date of issue of possession letter, he/she shall be liable to pay watch and ward charges at the prescribed rates beyond the period of 3 months from the date of issue of possession letter.

- 17.4. The flats are being offered on "as is where basis". DDA will not entertain any request for additions or alterations or any complaints whatsoever, regarding property circumstances as defined in Regulation 19 of the DDA (Management & Disposal of Housing Estate) Regulation 1968. DDA shall also not entertain a complaint about cost of flat, its design, and the quality of material used, workmanship or any other defects.
- 17.5. **In case allottee has deposited the full cost but has not submitted the requisite documents/ formalities within 3 month from the date of payment of full cost, applicable watch and ward charges will be levied upon him/her for the period delayed beyond 3 months and up to the month in which the complete documents are submitted or formalities are completed.**

18. CONVEYANCE DEED:-

- 18.1. The Conveyance Deed (Free Hold Deed) papers will be issued **online** by DDA only after taking over physical possession of the flat. The allottee may reserve a date for execution of Conveyance Deed online. The expenditure on e-stamping and other expenses on account of registration of Conveyance Deed, etc. in this regard shall be borne by the allottee.
- 18.2. The allottee shall not be entitled to transfer or otherwise part with the possession of the whole or any part of the flat before execution of Conveyance Deed. In the event of sale/ transfer being made without execution and registration of Conveyance Deed, such sale/transfer shall not be recognized by DDA and allotment of such flats will be cancelled.
- 18.3. The Conveyance Deed in the prescribed format transferring the title to the flat shall be executed in favour of the original allottee, only after taking over physical possession of the flat, which shall be registered with the Sub-Registrar as per law, upon receipt of all other dues provided the original allottee has not in any manner sold, transferred or alienated the whole or any part of the flat by any agreement, of whatsoever nature and/or parted with possession thereof.
- 18.4. **Date of execution of Conveyance Deed will be reserved by allottee through online mode only. Allottees are required to upload the copy e-stamp**



SPECIAL HOUSING SCHEME 2021

papers of the requisite value before reservation of date of execution of conveyance deed. On the reserved date, Allottees will have to come with all the original documents for the purpose of verification.

- 18.5. In the event of death of the original allottee prior to execution of Conveyance Deed, the Conveyance Deed shall be executed in favour of the legal heir(s) of the original allottee, as per policy/guidelines of DDA in respect of mutation.
- 18.6. Since a number of concessions are being offered under EWS category while working the cost of the flats, the allottees of EWS category flat would not be permitted to sell/ transfer or otherwise part with the possession of the flat in any manner for a period of Five (5) years from the date of taking over of physical possession of the flat.

19. STATUS OF THE ALLOTTEE :-

- 19.1. All allotments shall be made on free hold basis.

However, the title shall be transferred only when the Conveyance Deed is executed in favour of the allottee and it is registered in the office of the sub-Registrar, GNCTD. For Persons with Disability (Divyangjan) Conveyance Deed will be executed after realisation of entire cost of flat along with interest and other dues if any in case they choose to get allotment on hire –purchase basis. For persons belonging to EWS category, Conveyance Deed will be executed after a period 5 years as per clause 18 (v) in view of lock-in period.

20. INSPECTION OF FLAT:-

- 20.1. The applicants are advised to visit the site and inspect the flats and satisfy themselves with regard to location, size and cost of flats before applying under this scheme.
- 20.2. The contact numbers and addresses of the concerned Engineers to facilitate visit and inspection of the sample flat is as below :

JASOLA

S.No	Name of concerned Engineer	Designation	Mobile no.	Sample flat locality /Flat location
1	Sh. Sanjay Gupta	Asst. Engineer	9968070597	Jasola
2	Sh. Deepak Kumar Singh	Junior Engineer	8929772356	Jasola

VASANT KUNJ

S.No	Name of concerned Engineer	Designation	Mobile no.	Sample flat locality /Flat location
1	Smt. Madhuri	Ex. Engineer	9990367858	Vasant Kunj Block A, D & F
2	Sh. C.S. Rana	Ex. Engineer	9953481697	Vasant Kunj Block B, C & E
3	Sh. Bhuwan	Asst. Engineer	9868787022	Vasant Kunj Block A, D & F
4	Sh. Devesh Kansal	Junior Engineer	7073216029	Vasant Kunj Block A, D & F

DWARKA 19B

S.No	Name of concerned Engineer	Designation	Mobile no.	Sample flat locality /Flat location
1	Sh. Amit Singh	Ex. Engineer	8860894225	DWARKA 19B
2	Sh. Rambir Saini	Asst. Engineer	8800544093	DWARKA 19B
3	Sh. Kehar Singh Meena	Junior Engineer	9013489212	DWARKA 19B

DWARKA 16B

S.No	Name of concerned Engineer	Designation	Mobile no.	Sample flat locality /Flat location
1	Sh. H.S. Rawat	Ex. Engineer	9868533888	Dwarka 16 B
2	Sh. Manish Gupta	Asst. Engineer	9911303857	Dwarka 16 B
3	Sh. Anil Bansiwal	Junior Engineer	8094203392	Dwarka 16 B
4	Sh. Tikesh	Junior Engineer	9587204108	Dwarka 16 B

SIRASPUR

S.No	Name of concerned Engineer	Designation	Mobile no.	Sample flat locality /Flat location
1	Sh. Amit Kumar	Asst. Engineer	8178791202	Siraspur
2	Sh. Ravi Madhav	Junior Engineer	9555826430	Siraspur



SPECIAL HOUSING SCHEME 2021

ROHINI SEC 34 & 35

S.No	Name of concerned Engineer	Designation	Mobile no.	Sample flat locality /Flat location
1	Sh. Abhishek Khatri	Asst. Engineer	9958152605	ROHINI SEC 34 & 35
2	Sh. Sanjay Alaria	Junior Engineer	9958152605	ROHINI SEC 34 & 35
3	Sh. Nitish	Junior Engineer	9999289930	ROHINI SEC 34 & 35

NARELA

S.No	Name of concerned Engineer	Designation	Mobile no.	Sample flat locality /Flat location
1	Sh. J.Krishan	Asst. Engineer	9810933145	Sector G2,G7,G8 & Pkt 1A of Sector A1-A4 Narela
2	Sh. Mohit	Asst. Engineer	9971154443	Sector A5, A6 & B4 & Pkt- IB, IC of Sector A1-A4 Narela
3	Sh. Sonu Nagar	Junior Engineer	9929883898	Sector A1-A4,Pkt 1C & Sector A5 , Narela
4	Sh. Sanjay	Junior Engineer	8802032684	Sector A6, Sector B4 Narela
5	Sh. Sant Ram	Junior Engineer	9454005615	Sector A1-A4,Pkt 1B & Sector A9 Narela
6	Sh. Anujash Kumar	Junior Engineer	7903086772	Sector G2,G7,G8 & A1 to A4, Pkt 1A Narela

MANGLA PURI/EWS

S.No	Name of concerned Engineer	Designation	Mobile no.	Sample flat locality /Flat location
1	Sh. Mahesh Chand	Ex. Engineer	9868211866	Mangla Puri
2	Sh. Vijay kumar	Asst. Engineer	9213200667	Mangla Puri
3	Sh. Jay Ram	Junior Engineer	9882619416	Mangla Puri

20.3. Sample flats are located at above mentioned locations and will be available for inspection of Public on ALL SEVEN DAYS from 10:00 AM to 06:00 PM. During the period scheme is open a representative of DDA will be available On-site during these hours to facilitate inspection.

20.4. A dedicated Help Desk along with dedicated call centre will also start functioning at Nagrik Suvidha Kendra (NSK), Vikas Sadan from the date of launch of the Scheme, for resolving the issues of general public, if any.

(Divyangjan) as defined in Section-37(a) of the Rights of persons with Disabilities Act, 2016.

22.2. Attempt shall be made to make allotment of flats to persons with disability (Divyangjan) at ground floor.

22.3. The allotment belonging to persons with disability (Divyangjan) will have two option of payment i.e. allotment on hire purchase basis or on cash down basis. The initial payment in case of hire purchase allotment would be 25% of the total cost. Rest of the amount would be taken in monthly installments over a period up to 15 years.

22.4. 5% rebate in the cost subject to a maximum of 1.00 Lakh will be given to such allottees who are allotted flat under the above quota. The other conditions of allotment will remain the same. The conveyance deed papers will be executed in the name of original allottees only.

22.5. The letter of allotment of such flats would specifically state that alienation of possession of the flat prior to 15 years or payment of cost of flats with interest and other dues whichever is earlier, from the delivery of possession to the allottee would result in automatic cancellation of the flat and under no circumstances such cancellation would be withdrawn. In addition, the Conveyance Deed for all such cases would also include the following specific clause which would be included in the letter of allotment itself and the allottee should by way of affidavit specifically agree to the same being a part of

21. BENEFIT UNDER PMAY:-

21.1. The allottees may avail benefits under the Credit Linked Subsidy Scheme (CLSS) provided they are eligible under Pradhan Mantri Awas Yojna- Housing for All (Urban). To avail the benefits, the beneficiary family should not own a 'pucca' house either in his/her name or in the name of his/her family in any part of India. The application should be made preferably in the name of the female head of the household or in the joint name of the male head of the household and his wife. More details of Pradhan Mantri Awas Yojna – Housing for All (Urban) are available on page 2 and 3 of this brochure as well as on DDA's website.

22. PREFERENTIAL ALLOTMENT:-

22.1. 5% reservation is kept for persons with disability



the conveyance deed before the possession of the flat is delivered to the allottee.

22.6. The proposed clause would be as follows:

“That the allottee/vendee specifically agrees that he shall not part with possession of the whole or any part of the flat at any time prior to the expiry of 15 years or payment of cost of flats with interest and other dues whichever is earlier from the date of actual delivery of possession thereof by the vendor to the allottee/vendee and to that limited extent, the title in the property shall be deemed to continue to vest in the vendor. It is further specifically agreed that the case the allottee/vendee violates terms of the present conveyance deed, the entire conveyance deed shall be deemed to be void and in that eventuality, the vendor shall be entitled to take back possession of the demised property from the allottee/vendee”

22.7. In case the allottee/vendee dies prior to the expiry of the stated period of 15 years, his/her legal representatives and heirs shall be bound to honor the stated condition, but shall be entitled to occupy the said flat.

22.8. The concession shall be applicable to persons who come within the meaning of disability as defined in the Persons with disabilities (Equal Opportunities, protection of Rights and Full Participation) Act 2016 and duly certified by a Medical Board.

22.9. The permissible benefit under this clause will be given only to those applicants who have been allotted the flat under 5% reserved quota. If the flat is allotted under general category, the above benefit will not be extended to them in any case or manner whatsoever and they will neither claim such benefits nor any requests in this regard will be entertained by the DDA.

23. OTHER GENERAL CONDITIONS: -

23.1. DDA reserves the right to alter any terms and conditions/clause of the Scheme brochure at its discretion as and when considered necessary.

23.2. DDA reserves the right to increase or decrease the number of flat on offer under the Scheme. DDA also Reserves the right to withdraw some/all flats depending on the circumstances.

23.3. The allotment under this Scheme shall be on the terms and conditions contained in this brochure, demand cum allotment letter and the DDA (Management & Disposal of Housing Estate) Regulations, 1968.

23.4. As per provisions contained in Regulations No.17 of DDA (Management & Disposal of Housing Estate) Regulations 1986, all rates fees, taxes, charges assessment of municipal taxes and levies of whatsoever nature shall be borne by the allottee of the Registered Agency/ Association of Apartment Owners; as the case may be and shall be payable by the allottee of Association of Apartment Owners'/Registered Agency within the periods specified in this behalf.

23.5. Any dispute shall be subject to the jurisdiction of Courts/Consumer Court at Delhi/New Delhi only.

23.6. In all the correspondence within DDA regarding allotment etc., the applicants are advised to quote their Application Form No., File No, etc., and such correspondence be addressed to Dy. Director concerned D'-Block, Vikas Sadan DDA, New Delhi-110023.

23.7. In case of any grievance, the applicant can contact Director (H)-I/Director (H)-II, Commissioner (Housing), Principal Commissioner (Housing) or the Vice Chairman, DDA during their Public Hearing days. However, on financial issues, the applicant is advised to first contact Financial Advisor (Housing), D-Block 1st Floor Vikas Sadan, New Delhi-110023.

23.8. It is not possible to check the eligibility of applicant at the time of acceptance of the application. Applicants in their own interest should carefully fully go through the eligibility conditions before submitting their application. Those applicants who do not fulfill eligibility criteria would not be entitled for allotment of flats if at a later stage it is detected that they are not eligible under the Scheme.

23.9. Allottee will be required to intimate the source of payment. For the purpose, he/she will have to upload a copy of bank pass book. Bank Statement, loan documents, if raised.

23.10. The demand-cum-allotment letter will be issued on the basis of information/document furnished by the applicant in the Application Form for allotment of flat. In case, it is found at any stage that the documents/ information furnished by the applicant are incorrect/ false/ untrue, the allotment shall stand cancelled automatically without any notice and the claim of the applicant in such cases will not be entertained. The whole amount, including Application Money, will be forfeited.



Details of Flats, Tentative Cost And Locality Codes

S. No.	Locality	Locality Code	No. of Flats	Approx. Range of Plinth Area of flat (inSqm.)	Broad Range of Tentative Disposal Cost (Rs. In Lakh)
3 BHK/ HIG					
1	Jasola	11	182	162.41 to 177.26	197 to 214
2	Vasant Kunj Block F, Cluster 1 and Block A, Cluster 4*	12	18	128.52 to 141.13	144.82 to 166.94
3	Paschim Vihar (1 Flat), Dwarka Sector 18B (1 flat)	13	2	94.96 to 139.06	81.76 to 126.25
TOTAL HIG			202		
2 BHK/ HIG					
4	Vasant Kunj Block F, Cluster 1 and Block A, Cluster 4	21	3	114.41 to 114.42	135.55 to 135.56
TOTAL HIG			205		
2 BHK/ MIG					
5	Dwarka Sector 19 B, Pkt. 3	31	301	119.66 to 129.98	114 to 124
6	Dwarka Sector 16 B, Pkt. II	32	177	121.35 to 132.77	116 to 127
7	Vasant Kunj Block B to E, Cluster 2, 3, 5 & 6	33	6	85.156 to 91.8	84.71 to 91.25
8	Rohini, Sector 23, Pkt 6,7	34	16	81.14 to 88.17	59.90 to 65.55
9	Dwarka Sector 3,19	35	8	75.48 to 109.22	66.52 to 96.25
10	Jahangirpuri(6 Flats), Madipur (1 Flat)	36	7	67.41 to 99.73	50.25 to 65
11	NARELA Sector A1-4(459 flats), A-9 (2 flats)	37	461	79.68 to 114.69	59.50-100
TOTAL MIG			976		
LIG/One Bedroom					
12	Dwarka, Sector 23 B, Pkt8	41	7	33.291 to 33.853	24.65 to 25.65
13	Rohini Sector 16,20,21,22,28 & 29	42	27	43.36 to 48.51	19.65 to 41.11
14	Rohini Sector 34 & 35	43	2003	33.29 to 33.854	14.15 to 14.35
15	Narela Sector A-9,A-10, B-2	44	11	41.73 to 52.63	18.22 to 21.42
16	Narela Sector G-2	45	515	33.291 to 33.851	18.10 to 18.32
17	Narela Sector G-8	46	1223	33.251 to 33.851	18.10 to 18.32
18	Narela, Sector-G7	47	6546	49.90	22.80
19	Ramgarh	48	219	31.90 to 35.34	15.50 to 17.02
20	Molarbund(1), Zafrabad(1),Kondli Gharoli (2)	49	4	31.34 to 54.63	22.25 to 36.90
21	Siraspur	50	750	35.76 to 36.39	17.50 to 17.75
22	Lok Nayak Puram	51	147	42.52 to 43.93	27.50 to 28.50
TOTAL LIG			11452		
EWS/JANTA					
23	Manglapuri, Dwarka (EWS)	61	79	50.74 to 52.50	28.51 to 29.50
24	Narela, Sector A-5, A-6 & B-4 (JANTA)	62	25	26.11 to 28.19	7.91 to 11.45
25	Narela Sector A1 to A4, Pkt 1A, 1B & 1C (EWS)	63	5033	46.71-54.08	10.75 to 12.42
26	Narela, Pkt-IV & V, Sector-G7 (EWS)	64	551	35.5	10
27	Rohini, Sector-4 (JANTA)*	65	12	28.01 to 28.81	10.50 to 11.50
28	Shivaji Marg(EWS)*	66	2	33.32	17
TOTAL EWS/JANTA			5702		
TOTAL			18335		

Note:-

- Number of flats may change at the time of draw and number of flats at particular Locality/Zone may be changed subject to availability.
- Size of the flat varies from flat to flat. The demand letter will be issued as per actual size of the individual flat.
- The Standard/ Typical unit plan of Housing in respect of localities are annexed at Annexure-G
- Plinth Area includes common area.



LIST OF EMPANELLED BANKS WITH THEIR NODAL BRANCHES

Sr. No.	Name of Bank, Saving Bank A/c No. & IFSC Code	Nodal Officer/ Branch Web address of Bank
1	STATE BANK OF INDIA S.B A/c No. 10938402189 IFSC Code SBIN0008005	C-Block, Vikas Sadan, INA, New Delhi-110023 www.onlinesbi.com Shri Adity Gupta, Cont. No. 99110096110
2	CENTRAL BANK OF INDIA S.B A/c No. 1014043747 IFSC Code CBIN0282695	C-Block, Vikas Sadan, INA, New Delhi-110023 www.centralbankofindia.com Shri Rajesh Jha, Cont. No. 9717463425
3	IDBI S.B A/c No. 011104000279482 IFSC Code IBKL0000011	Surya Kiran Building, G.F. 19, K.G. Marg, Cannought Place, New Delhi-110001 www.idbi.com Shri Parveen Kumar Bagri Cont. No.-011-66083420/ 21
4	BANK OF MAHARASHTRA S.B A/c No. IFSC Code	UPSC, Dholpur House, Shahajahan Road, New Delhi-110011 www.bankofmaharashtra.in Shri Pramod Kumar Cont. No. 011-23070653, 8408023525, 8595638650
5	HDFC Bank S.B. A/C No. 50100278607556 IFSC Code-HDFC0000503	B6/3, DDA Commercial Complex, Safdarjung Enclave, Opposite Deer Park, New Delhi-110029 www.hdfcbank.com Sh. Arun Kumar Chaudhary Cont. No. 93132079787
6	AXIS BANK S.B A/c No. 049010100452496 IFSC Code UTIB0000049	Eros Corporate Tower, Ground Floor, Nehru Place, New Delhi- 110019 www.axisbank.com Shri Rajive Das Gupta Cont. No. 9582800492, 7838017364
7	ICICI BANK S.B A/c No. 007101052702 IFSC Code ICIC0000071	9A, Phelps Building, Connought Place, New Delhi-110001 www.icicibank.com Shri Anish Munshi, Cont. No. 011-46085800
8	YES BANK S.B A/c No. 000394600000642 IFSC Code YESB0000003	Retail Block, Upper Ground Floor, DLF Cyber City, Tower 8 C, Gurgaon-122002 www.yesbank.in Cont. No. 0124-4619226
9	KOTAK MAHINDRA BANK S.B A/c No.0312809568 IFSC Code KKBK0000175	A-1/24, Safdarjung Enclave, New Delhi-110029 www.kotak.com Smt. Neha Vohra, Cont. No. 9582218058
10	INDUSIND BANK S.B A/c No. 151947196600 IFSC Code INDB0001035	Indusind Bank Ltd., Ground Floor, Plot No.12, Jor Bagh Market, New Delhi-110003 www.indusind.com 1. Shri Dhiraj Sharma, Cont. No. 8826200440 2. Shri Puneet Bhatia, Cont. No. 7838786807
11	IDFC FIRST BANK S.B A/c No. 10019718891 IFSC Code IDFB0020101	IDFC First Bank Ltd, Soodh & Birla Towers, 4th Floor, East Tower & LGF, West Tower, Barakhamba Road, New Delhi-110001 www.idfcbank.com 1. Shri Pushkal Dhar Dwivedi, Cont. No. 9899931383 2. Shri Maheshwari Nandan, Cont. No. 9990010565



AFFIDAVIT

(NOTE: This affidavit should be on a non-judicial stamp paper/e-stamp paper of Rs. 10/- and shall be attested by Magistrate/Sub-Judge/Notary Public and an extra stamp worth Rs. 5/- should be affixed thereon.)

Affidavit of Sh. /Smt. _____ s/o/d/o/w/o Shri _____ r/o _____ solemnly affirm and state as under:

1. I am a citizen of India.
2. I or my wife/husband or any of my dependent relations, including unmarried children does not own in full or in part on free hold or lease hold basis a residential plot having area exceeding 67 sqm or flat/built up house having carpet area exceeding 67 sqm in the urban area of Delhi, New Delhi and Delhi Cantonment.
3. I am applying for allotment of only one dwelling unit.
4. I have attained the age of majority at the time of applying under DDA Housing Scheme – 2021. My Date of Birth is _____
5. That the joint applicant under the Scheme is my _____ (relationship), as per provision of Clause 2(xi) of the Scheme Brochure.
6. That my wife /husband has also applied for allotment of a flat under the DDA Housing Scheme – 2021 vide Application No. _____. She /He was declared successful. He/She has surrendered the said flat on _____ or she/he has not been declared successful. (Strike out which is not applicable).
7. I have not sold, transferred, assigned or parted with the possession of the whole or any part of the residence at No. _____ allotted to me against my Application No. _____ in the draw held on _____ by the DDA. That I have not executed any Sale Agreement, Power of Attorney or Agreement to Sale in favour of anybody.
8. That, I, _____ S/o D/o W/o Shri _____ r/o _____ applied for allotment of EWS/LIG/MIG/HIG flats under DDA Housing Scheme – vide Application No. _____ and that I have been allotted a flat No. _____, Pkt. _____ Sec. _____, Locality _____ vide allotment letter No. _____ dated _____. That I am entitled for possession of the flat.
9. That Smt. _____ d/o Shri _____ is my legally wedded wife.
10. I have read, understood and before filling the Application Form I have accepted all the terms and conditions of the Brochure of Housing Scheme – 2021.

DEPONENT

VERIFICATION:

I, _____, do hereby verify that the facts mentioned in Paras 1 to 10 above are correct to the best of my knowledge and belief and nothing is false therein and nothing material has been concealed.

DEPONENT

Place

Date



AFFIDAVIT FROM SPOUSE (HUSBAND/WIFE)

(NOTE: This affidavit should be on a non-judicial stamp paper/e-stamp paper of Rs. 10/- and shall be attested by Magistrate/Sub-Judge/Notary Public and extra stamp worth Rs. 5/- should be affixed thereon.)

Affidavit of

Sh./Smt. _____ S/o/W/o Shri/Smt. _____

R/o _____

I aforesaid solemnly affirm and declare as under:

1. That Shri/Smt. _____ -- _____ S/o/W/o _____ is my legally wedded husband/Wife.

DEPONENT

VERIFICATION:

I, _____, solemnly affirm and say that facts mentioned in Para 1 above is correct to the best of my knowledge and nothing is false therein and no material has been concealed.

DEPONENT

Place

Date



UNDERTAKING

(NOTE: This undertaking should be on a non-judicial stamp paper/e-stamp paper of Rs. 10/- shall be attested by Magistrate/Sub-Judge/Notary Public and an extra stamp worth Rs. 5/- should be affixed thereon.)

WHEREAS, I, _____ S/o/D/o/W/o Shri _____
R/o _____ on an application made to the Delhi Development Authority under the Delhi Development Authority (Management & Disposal of Housing Estates) Regulations, 1968 (hereinafter called the said Regulation) have been allotted a _____ (hereinafter called the flat).

AND WHEREAS under the said Regulation, it is obligatory on my part to form a registered agency with the Vice-Chairman, DDA for the management and administration of the common portions and common services attached to the flats, execute the conveyance deed for the flat and joint lease deed for the land, under the appurtenant to the flats before the possession of the flat is handed over to me.

AND WHEREAS I in my own interest have applied to Delhi Development Authority for the possession of the flat allotted for immediate occupation, before the completion of the various formalities required to be performed by me under the said regulations and execution and Application of the documents provided in the Regulations.

I, _____ S/o/D/o/W/o Shri _____
R/o _____ on an application made to the Delhi Possession of the flat allotted being given to me earlier, I shall abide by all the terms and conditions that are set forth in the DDA (Management and Disposal of Housing Estates) Regulations, 1968, including the documents containing therein, or may be set forth in the Conveyance Deed for the flat and the joint lease deed for the land under the appurtenant to the flats by the Delhi Development Authority and shall sign and execute the same with the Delhi Development Authority and get the same registered at my own cost and expenses in the manner prescribed under the said Regulations within 90 days from the date of handing over the possession of the flat or such extended period as may be permitted by the Vice Chairman of Delhi Development Authority from time to time and that during the said period of 90 days of such extended period as may be permitted, I shall be responsible for looking after the maintenance of the common service attached to the flat allotted.

I, further undertake that we shall constitute and become, a member of the Registered Agency prescribed under the said Regulation and abide by the constitution, a model form of which I have read and understood.

I, also undertake not to make any addition and alteration in the dwelling unit allotted to me without obtaining prior and written permission from the DDA. It will be open to DDA to cancel the allotment and resume the possession of the dwelling unit, if I fail to fulfill the undertaking given herein.

Signed by me _____ on _____ day of _____ Two Thousand Nineteen.

In the presence of witnesses:-

- 1.
- 2.

ALLOTTEE



(NOTE: Should be attested by Magistrate/Sub-Judge/Notary Public/Gazetted officer)

Specimen signature and photograph of Shri/Smt./Km. _____

S/o/W/o/D/o _____

R/o _____

_____ and

Smt./Shri/Km. _____ S/o/W/o/D/o _____

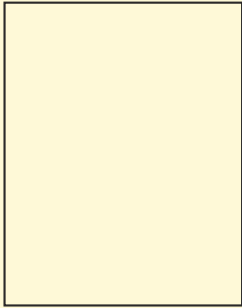
Specimen Signature of Shri		
1		
2		
3		

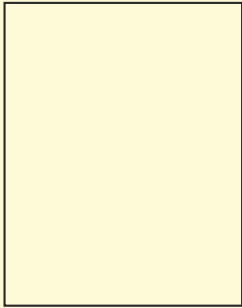
Specimen Signature of Shri		
1		
2		
3		

TYPICAL UNIT PLAN LAYOUT OF HIG FLATS AT JASOLA POCKET 9B



TYPICAL UNIT PLAN LAYOUT OF HIG FLATS AT JASOLA POCKET 9B

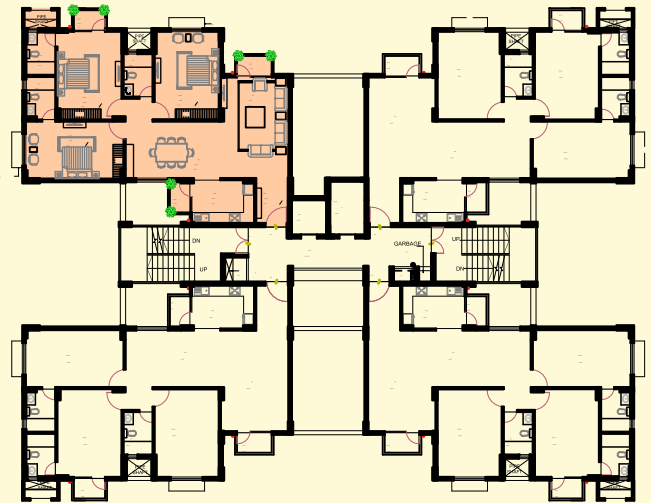

CLUSTER PLAN



TYPICAL UNIT PLAN LAYOUT OF EWS FLATS AT MANGLAPURI, DWARKA



TYPICAL UNIT PLAN LAYOUT OF MIG FLATS AT SECTOR 19B, DWARKA



TYPICAL UNIT PLAN LAYOUT OF MIG FLATS AT SECTOR 16B, POCKET-2, DWARKA

348 Multi Story MIG Houses at Sector-16B, Pocket-2, Dwarka Phase-II
(Near Sector-14 Metro Station Dwarka)

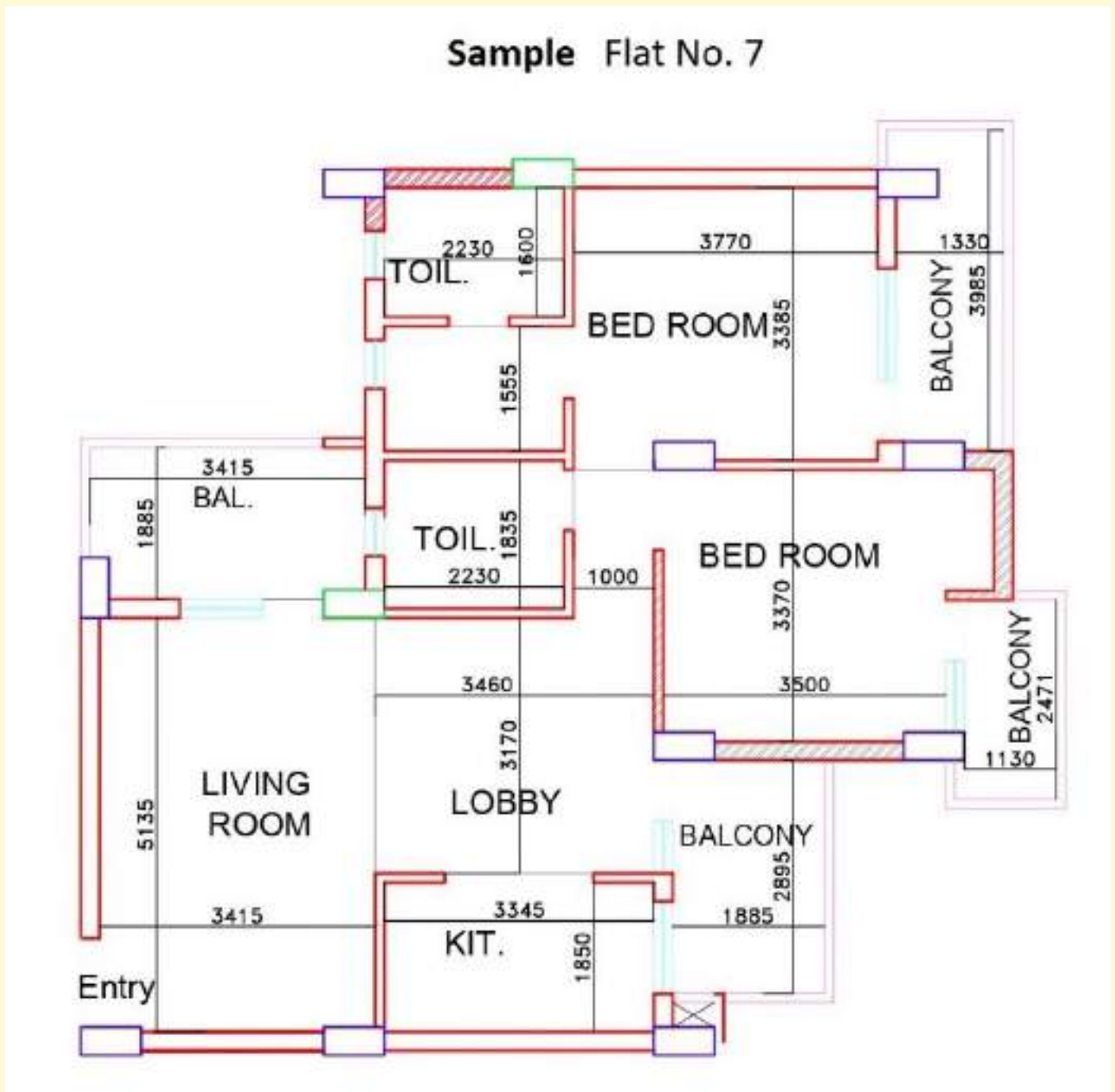

**TYPICAL UNIT PLAN OF EWS & CAT II (MIG/2BHK)
FLATS AT PKT-1A, SEC. A1 to A4, NARELA**



**TYPICAL UNIT PLAN OF EWS & CAT II (MIG/2BHK)
FLATS AT PKT-1B, SEC. A1 to A4, NARELA**



**TYPICAL UNIT PLAN OF EWS & CAT II (MIG/2BHK)
FLATS AT PKT-1C, SEC. A1 to A4, NARELA**



**TYPICAL UNIT PLAN OF EWS & CAT I (LIG/1BHK)
FLATS AT PKT-IV, SEC. G8, NARELA**



TYPICAL UNIT PLAN OF EWS & CAT I (LIG/1BHK)
FLATS AT PKT-V, SEC. G8, NARELA



TYPICAL UNIT PLAN OF HIG (3 BHK) FLATS AT VASANT KUNJ

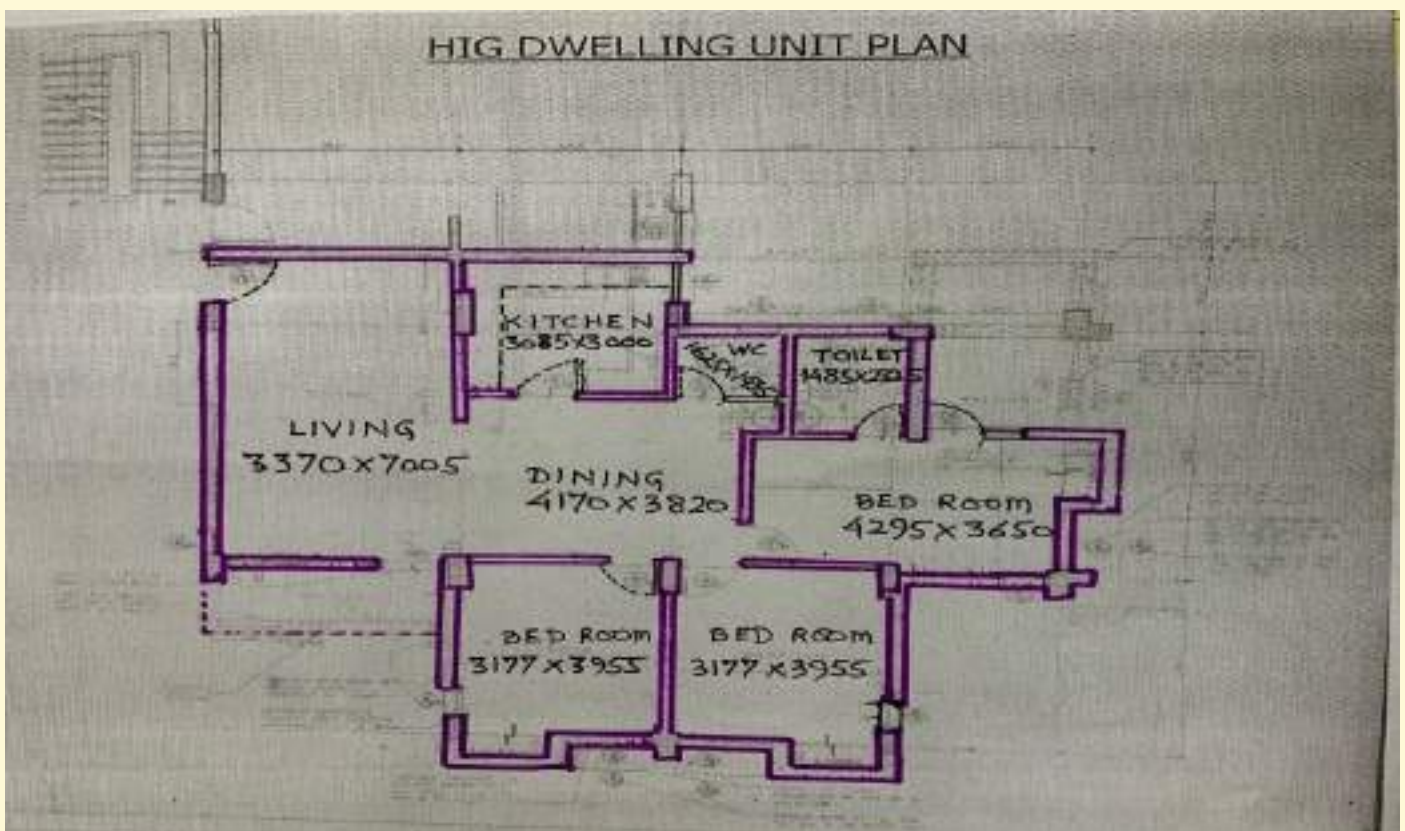

TYPICAL UNIT PLAN OF MIG (2 BHK) FLATS AT VASANT KUNJ

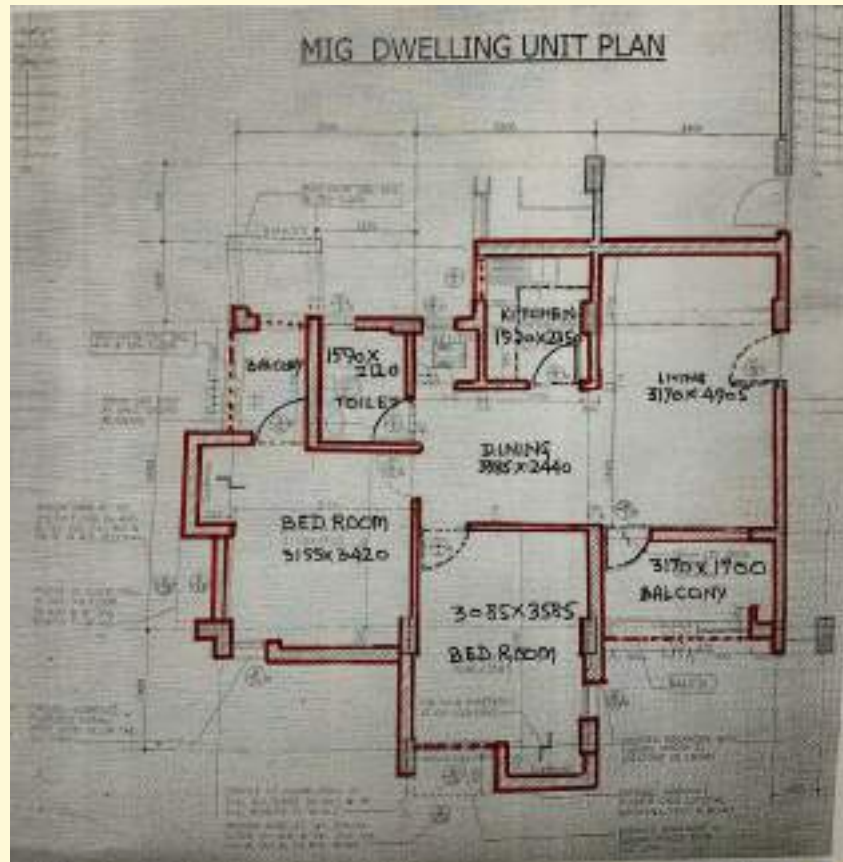

TYPICAL UNIT PLAN OF LIG (1 BHK) FLATS AT VASANT KUNJ

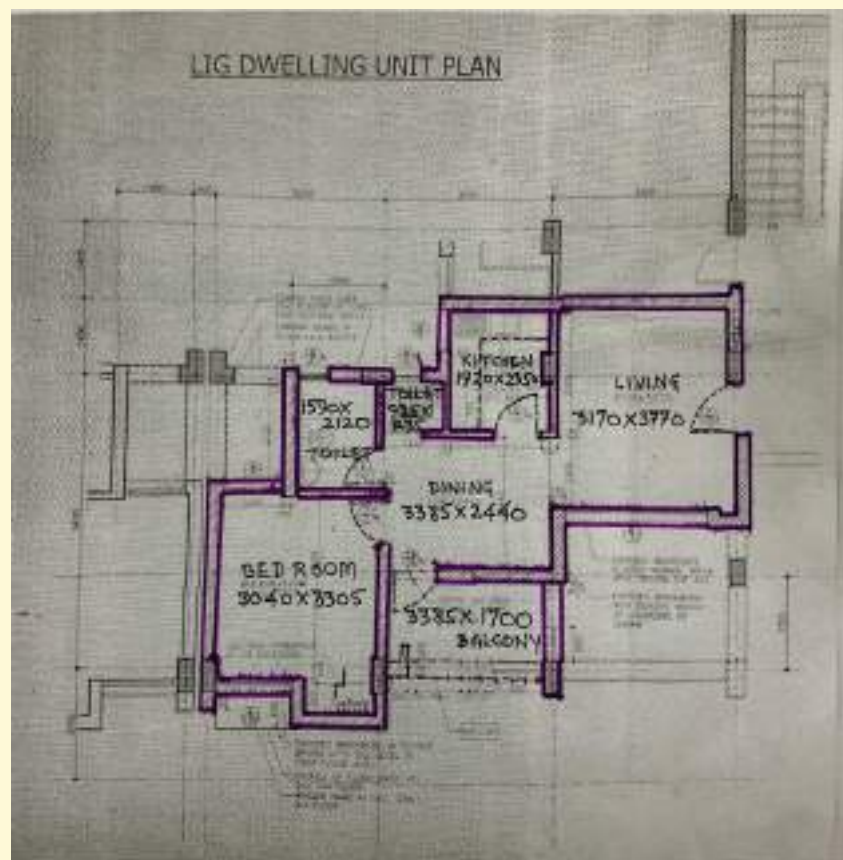

Upcoming DDA Sports Complex,

A-7 Narela (North Delhi) Centre of Excellence for Athletics

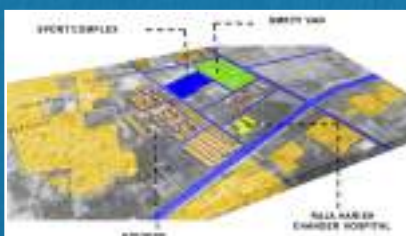



Flats on Free Hold

Contact:

DELHI DEVELOPMENT AUTHORITY

Room No.214, IInd Floor, D-Block,
Vikas Sadan, INA, New Delhi-110023.

Website: www.dda.org.in

Helpline No.: 1800110332